

PLUS

Francesco Rota | 2017





Francesco Rota | 2017

Pouf, sofa, relaxation island: around a blue swimming pool or a green garden, the PLUS sofa invites us to pleasant outdoor moments. An idea is an addition. PLUS. An addition because this system of modular elements offers unparalleled elegance and versatility. An addition because the soft and attractive profile of each solution, from the pouf to the chair and sofa, extends to accommodate a body in the lying position. An addition because thanks to an extremely simple hooking system it just takes a second to re-arrange and redesign the profile. More than an idea, it is a world.



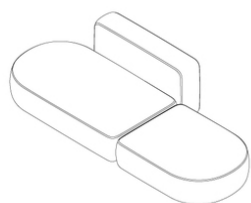

Classic curved

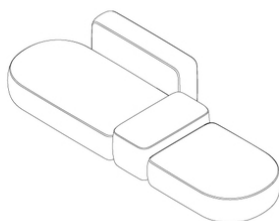

Classic curved – medium

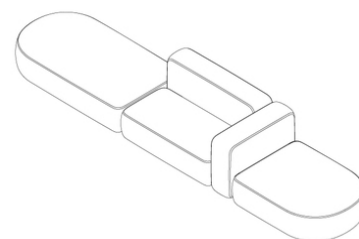

Classic curved – big

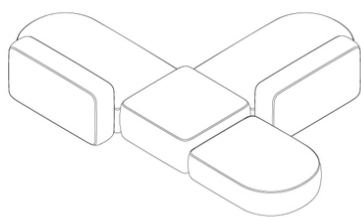

T_shape

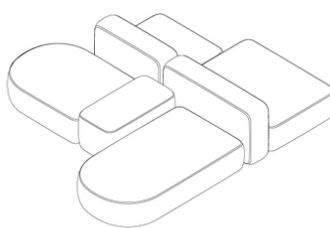

Island - 1

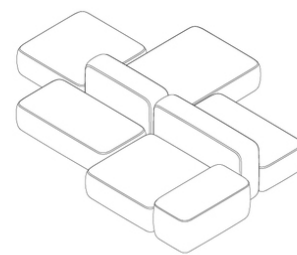

Island - 2

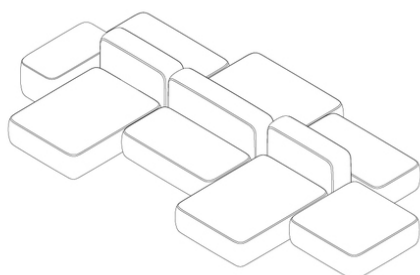

Island - 3

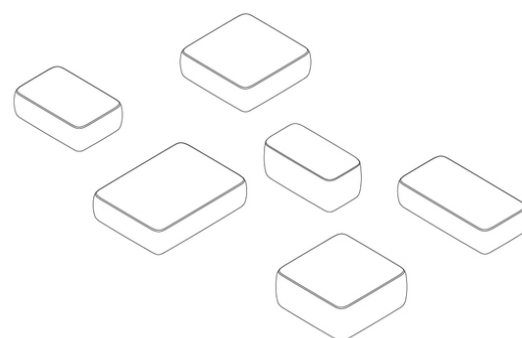

Pouf

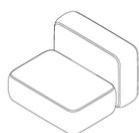

Armchair - 1

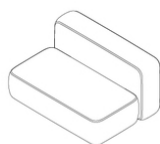

Armchair - 2

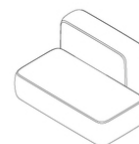

Armchair - 3

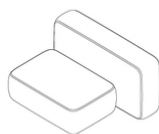

Armchair - 4

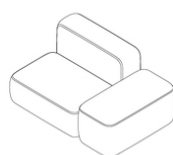

Armchair - 5

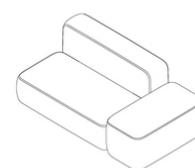

Armchair - 6

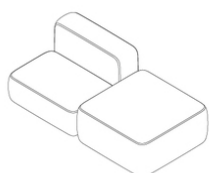

Armchair - 7

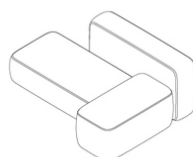

Armchair - 8

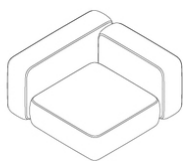

Chaise longue - 1

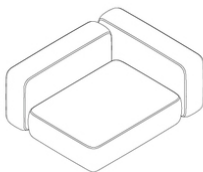

Chaise longue - 2

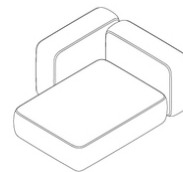

Chaise longue - 3

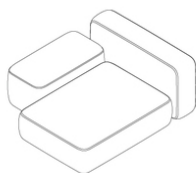

Chaise longue - 4

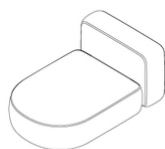

Chaise longue - 5

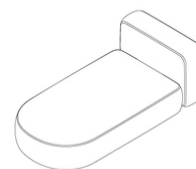

Chaise longue - 6

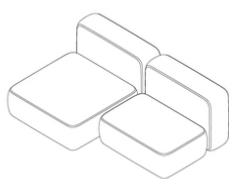

Small chaise longue - 1

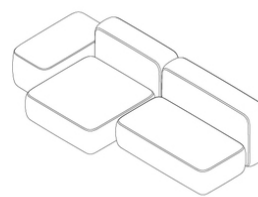

Small chaise longue - 2

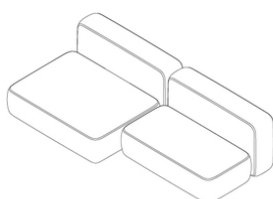

Large chaise longue - 1

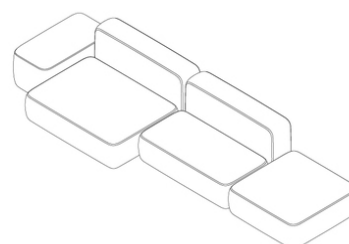

Large chaise longue - 2

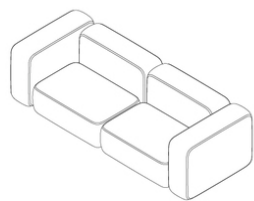

Small — double

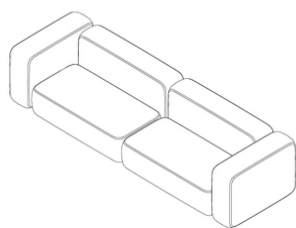

Large — double

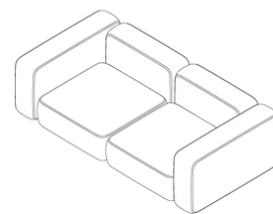

Small — deep

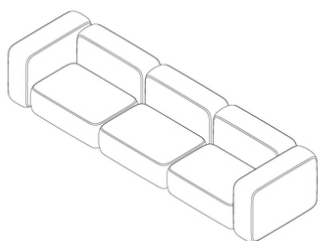

Small — triple

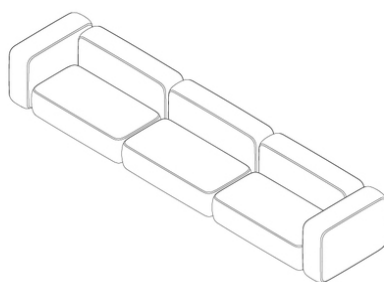

Large — triple

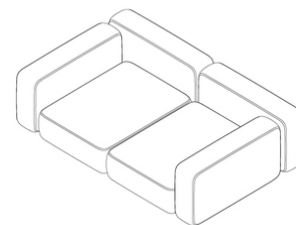

Large — deep

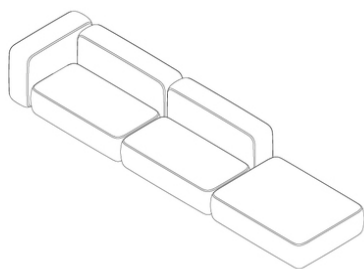

Large — open - 1

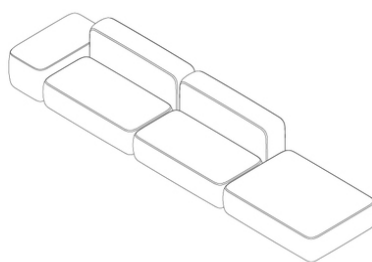

Large — open - 2

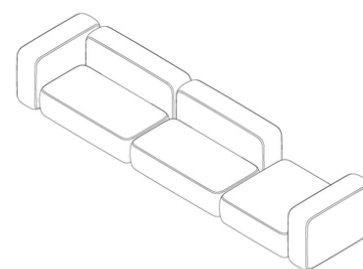

Large — open - 3

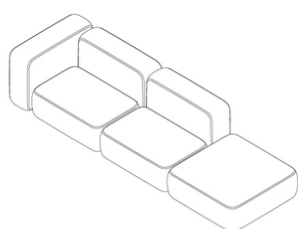

Small — open - 1

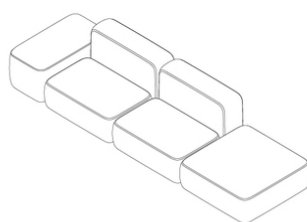

Small — open - 2

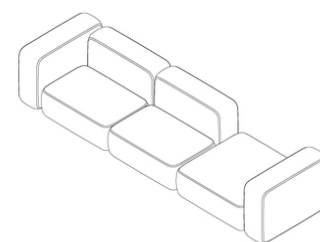

Small — open - 3

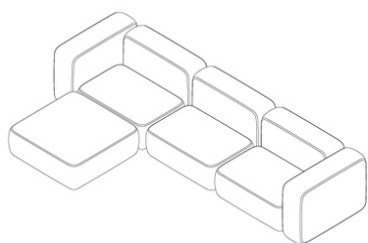

L_shape - 1

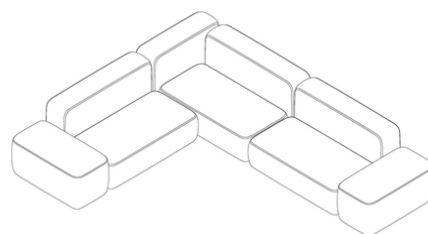

L_shape - 2

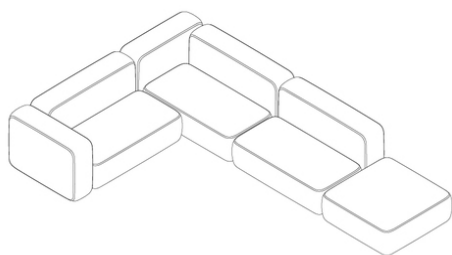

L_shape - 3

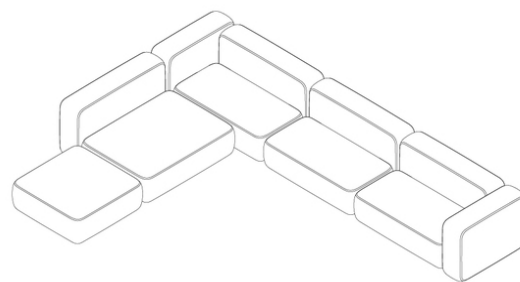

L_shape - 4

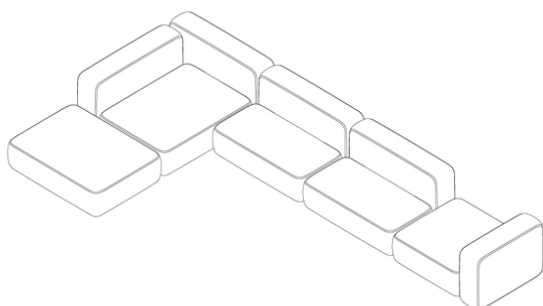

L_shape - 5

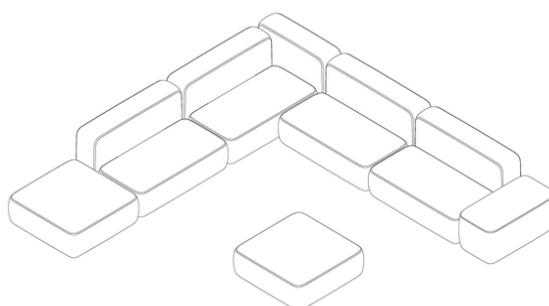

L_shape - 6

PLUS

Francesco Rota | 2017

Modular seating system in polyurethane foam with variation in density and polyester fiber, all fire-retardant, with protective water-resistant and breathable fabric layer and finished with UV stable outdoor fabric. Internal base in marine plywood with plastic springs and an aluminium frame using diecast aluminium brackets to link each element. Water-resistant protective covers are available. PLUS can be matched with OORT cushions.

TEST EN 1728:2012 AC:2013 6.17 - EN 16139:2013 - L2 extreme

TEST EN 1728:2012 AC:2013 6.17 - EN 16139:2013 - L2 extreme

TEST 1 IM - Hallingdal, Maya, Tonica

seats

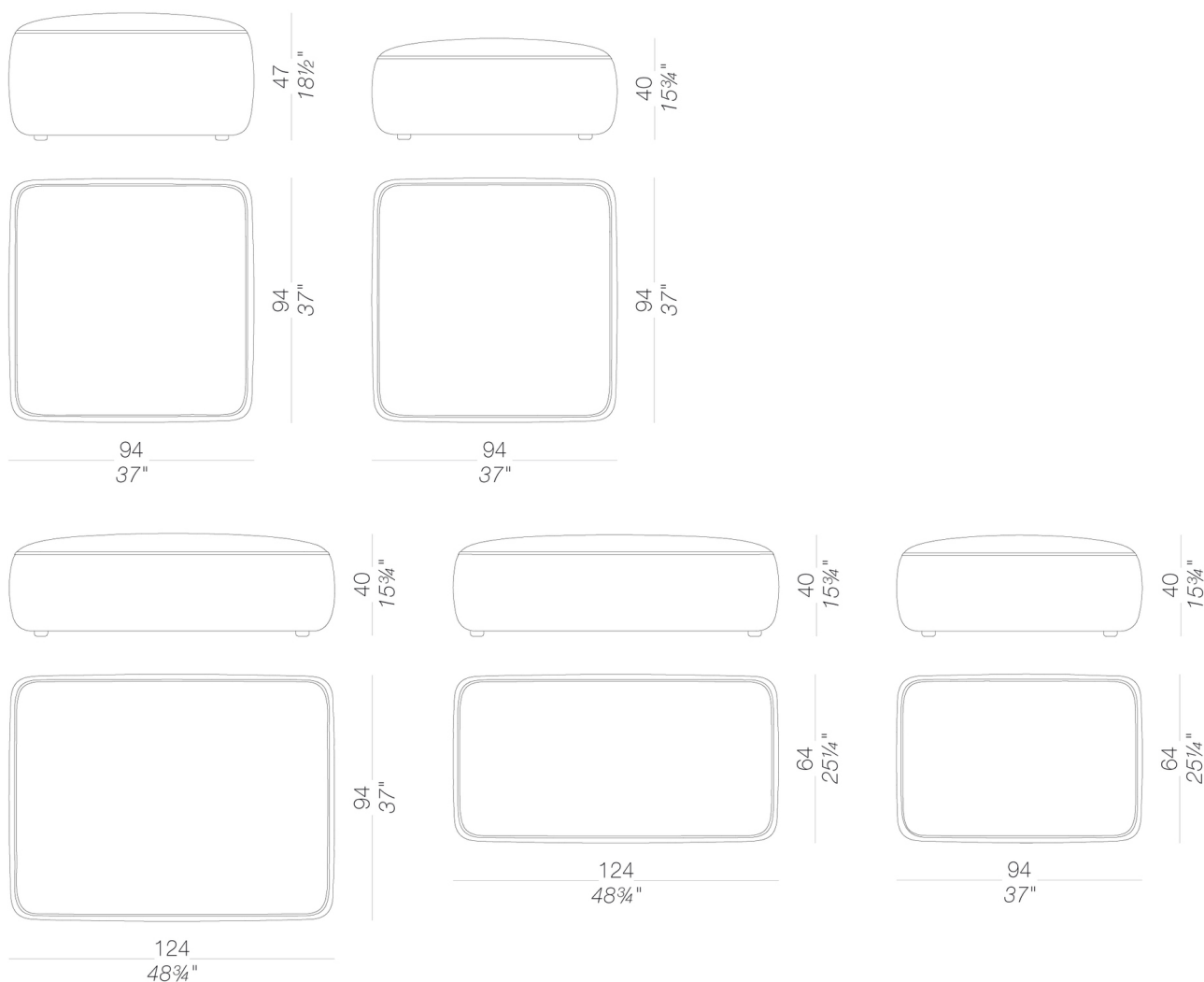

PLUS

Francesco Rota | 2017

seats

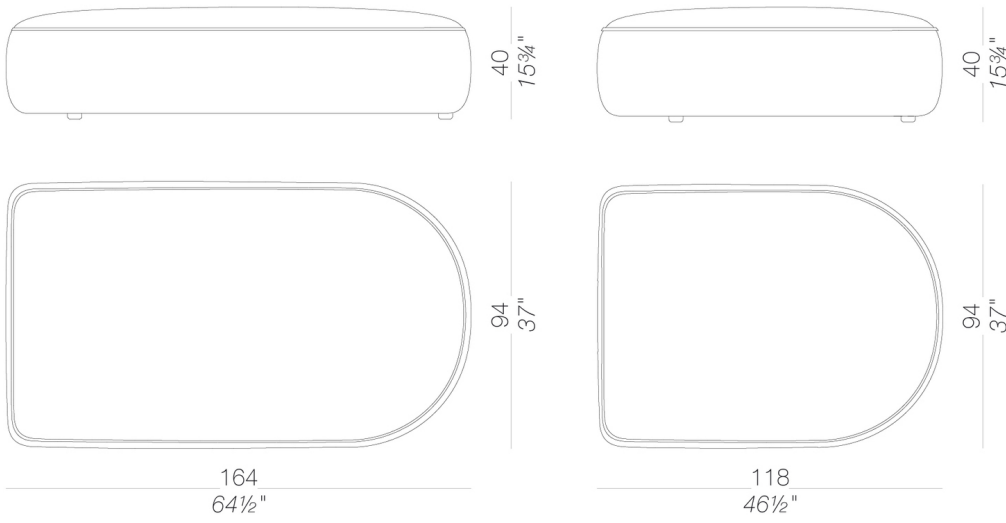

backrests

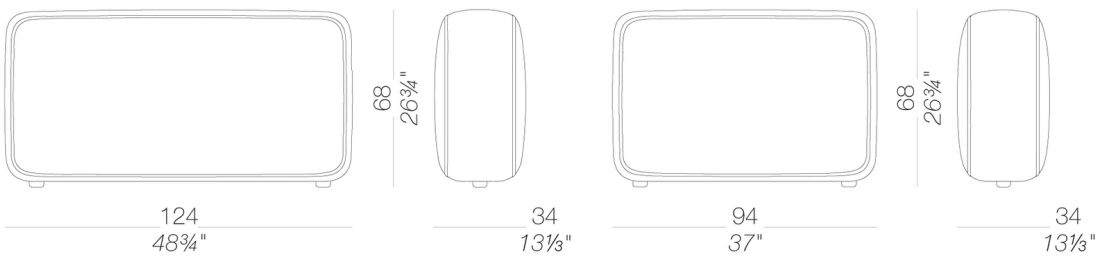

armrest

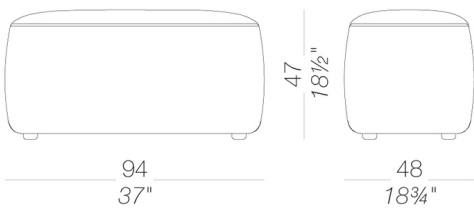

upholstery

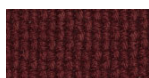

fabric
Lapalma Smart -
Grade C
18 Colors



fabric
Nattè - Grade B
30 Colors



fabric
Iliris - Grade B
24 Colors

linking bracket

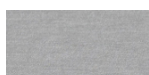

metal
aluminium
1 Colors

consult the folder of materials for the range of colors and fabrics

use and maintenance instructions

Outdoor fabrics are lined unglued, therefore any creasing in the upholstery is an inevitable consequence of use and cannot be considered grounds for any claims. Do not use detergents containing bleach, hydrochloric acid or products containing chloride on any metal parts. Salt, limescale or acid (from coffee, wine, orange juice, tomato juice, lemon, etc.) may discolour stainless steel parts if they are not promptly cleaned. Products or parts made of stainless steel used near the sea or in interior fittings of swimming pools require more frequent cleaning to remove chloride deposits and prevent corrosion and chemical attack of the external surface. Stains on stainless steel surfaces must be promptly cleaned. If left for a long time they can become permanent.

To prolong the life of the product, clean the surfaces regularly, dry them with a clean cloth and remove any stagnant water, especially if exposed in locations with a high level of humidity or a marine climate. When not in use, we recommend storing in sheltered places and covering with waterproof protection. In this case, it is advisable to remove the cover and ventilate the product frequently and regularly to avoid the onset of any mould or stains due to damp.

THE WARRANTY WILL NOT COVER DEFECTS OR IMPERFECTIONS RESULTING FROM THE PASSAGE OF TIME OR TO WEAR AND TEAR DUE TO THE NORMAL USE OF THE PRODUCT.