

Version: 4-4-2023

www.gazzda.com



GAZZDA

Hugg Modular Sofa

Product sheet

design by
Mustafa Čohadžić



Hugg Modular Sofa

Product facts

Materials

Body	Fabric upholstery HR foam Wooden construction
Side	Oak veneer
Legs	Solid oak
Finish	Lacquered

Technical features

Upholstery

The Hugg Modular Sofa is suitable for both home and contract environments. It is upholstered in a base raw cotton upholstery, with removable top covers available in different fabric options. For further information please see the Available materials and colours page in this document.

Construction

The wooden back frame is layered with cold cast HR foam 25/30 and polyester wadding, while the wooden seat frame is covered with zig-zag springs, felt, HR foam 35/40 and polyester wadding.

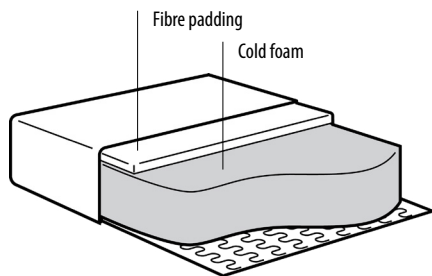

Wooden parts

The legs of the Hugg Sofa are crafted from solid oak, while the armrest side detail is made of formpressed veneer.

Finish

The wooden parts of the Hugg Sofa are available in natural or black lacquered options.

Cleaning

Please see [Product](#) or [Material](#) page on our website.

Notes to consider

Variations

Natural variations in wood color and surface may occur. Regular maintenance will ensure the wood preserves its authentic beauty and can last for generations.

Product changes

Please note that Gazzda reserves the right to alter construction and design without notice.

Dimensions (tolerances)

The dimensions shown are indicative, they may vary due to the natural properties of wood, season, or manufacturing processes. Deviations from the specified size may occur, usually no more than 1 cm.

For all additional inquiries regarding Hugg Modular Sofa units please feel free to [contact us](#).

Hugg Modular Sofa Right Armrest - HRA 80

Upholstery **Fabric**, Wooden parts **Oak**

Basic info

Design Mustafa Čohadžić

Product size W: 100, D: 100, H: 76

Packaging W: 104, D: 104, H: 80

Volume 0,87 m³

Net weight 44,2 kg

Gross weight 51,2 kg

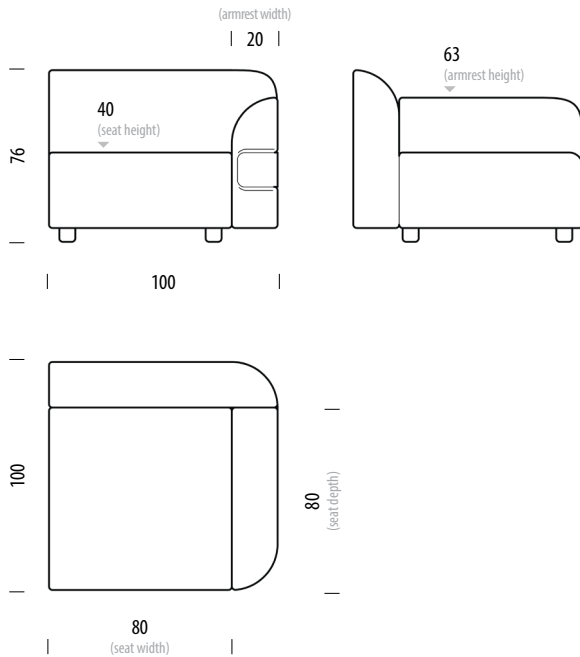

Item no. 569

Removable fabric covers • Assembled module
Assembly between modules 5 min / 2 persons

Dimensions	Width	Depth	Height
Seat	80	80	40
Armrest	20	80	63

Selected options

Wooden parts

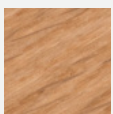

Lacquered
LUA468
Natural

Fabric upholstery



Main line flax
MLF02
Archway

Indicated materials and colours are selected by Gazzda as best-selling items. The lead time of selected options is 1-5 weeks. For an accurate lead time, please consult customer service.

For other material options, please see the Available materials section at the end of the product sheet.

Hugg Modular Sofa Left Armrest - HLA 80

Upholstery **Fabric**, Wooden parts **Oak**

Basic info

Design Mustafa Čohadžić

Product size W: 100, D: 100, H: 76

Packaging W: 104, D: 104, H: 80

Volume 0,87 m³

Net weight 44,2 kg

Gross weight 51,2 kg

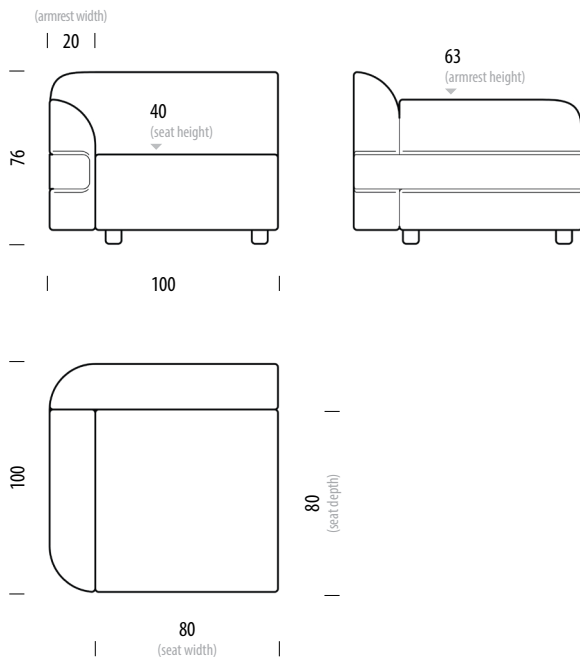

Item no. 44F

Removable fabric covers • Assembled module
Assembly between modules 5 min / 2 persons

Dimensions	Width	Depth	Height
Seat	80	80	40
Armrest	20	80	63

Selected options

Wooden parts

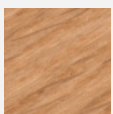

Lacquered
LUA468
Natural

Fabric upholstery



Main line flax
MLF02
Archway

Indicated materials and colours are selected by Gazzda as best-selling items. The lead time of selected options is 1-5 weeks. For an accurate lead time, please consult customer service.

For other material options, please see the Available materials section at the end of the product sheet.

Hugg Modular Sofa Corner - HC 80

Upholstery **Fabric**, Wooden parts **Oak**

Basic info

Design Mustafa Čohadžić

Product size W: 100, D: 100, H: 76

Packaging W: 104, D: 104, H: 80

Volume 0,87 m³

Net weight 50,8 kg

Gross weight 56,2 kg

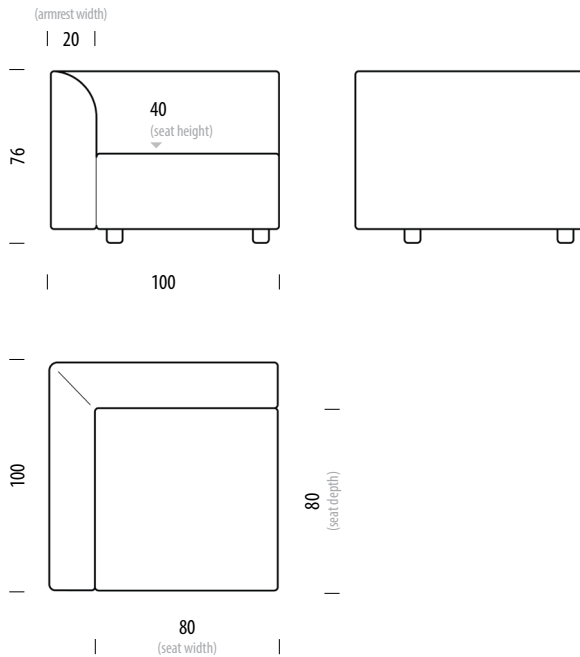

Item no. 3ED

Removable fabric covers • Assembled module
Assembly between modules 5 min / 2 persons

Dimensions	Width	Depth	Height
Seat	80	80	40
Armrest	20	80	63

Selected options

Wooden parts

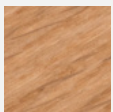

Lacquered
LUA468
Natural

Fabric upholstery



Main line flax
MLF02
Archway

Indicated materials and colours are selected by Gazzda as best-selling items. The lead time of selected options is 1-5 weeks. For an accurate lead time, please consult customer service.

For other material options, please see the Available materials section at the end of the product sheet.

Hugg Modular Sofa Right Lounge Armrest - HRLA 170

Upholstery **Fabric**, Wooden parts **Oak**

Basic info

Design Mustafa Čohadžić

Product size W: 100, D: 170, H: 76

Packaging W: 104, D: 174, H: 80

Volume 1,45 m³

Net weight 55,3 kg

Gross weight 64,7 kg

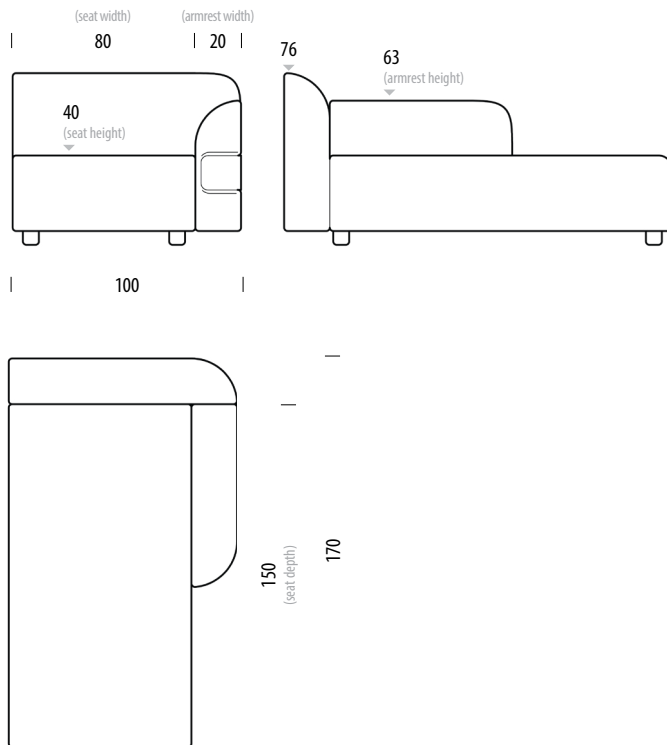

Item no. 56B

Removable fabric covers • Assembled module
Assembly between modules 5 min / 2 persons

Dimensions	Width	Depth	Height
Seat	80	150	40
Armrest	20	80	63

Selected options

Wooden parts

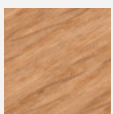

Lacquered
LUA468
Natural

Fabric upholstery



Main line flax
MLF02
Archway

Indicated materials and colours are selected by Gazzda as best-selling items. The lead time of selected options is 1-5 weeks. For an accurate lead time, please consult customer service.

For other material options, please see the Available materials section at the end of the product sheet.

Hugg Modular Sofa Left Lounge Armrest - HLLA 170

Upholstery **Fabric**, Wooden parts **Oak**

Basic info

Design Mustafa Čohadžić

Product size W: 100, D: 170, H: 76

Packaging W: 104, D: 174, H: 80

Volume 1,45 m³

Net weight 55,3 kg

Gross weight 64,7 kg

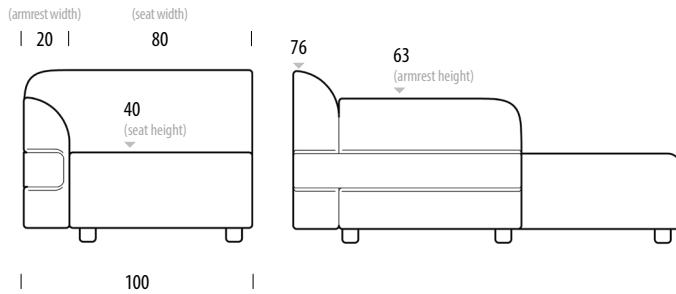

Item no. 55F

Removable fabric covers • Assembled module
Assembly between modules 5 min / 2 persons

Dimensions	Width	Depth	Height
Seat	80	150	40
Armrest	20	80	63

Selected options

Wooden parts

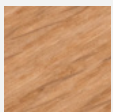

Lacquered
LUA468
Natural

Fabric upholstery



Main line flax
MLF02
Archway

Indicated materials and colours are selected by Gazzda as best-selling items. The lead time of selected options is 1-5 weeks. For an accurate lead time, please consult customer service.

For other material options, please see the Available materials section at the end of the product sheet.

Hugg Modular Sofa Right Open Ended - HROE 130

Upholstery **Fabric**, Legs **Solid oak**

Basic info

Design Mustafa Čohadžić

Product size W: 130, D: 100, H: 76

Packaging W: 134, D: 104, H: 80

Volume 1,11 m³

Net weight 42,4 kg

Gross weight 49,9 kg

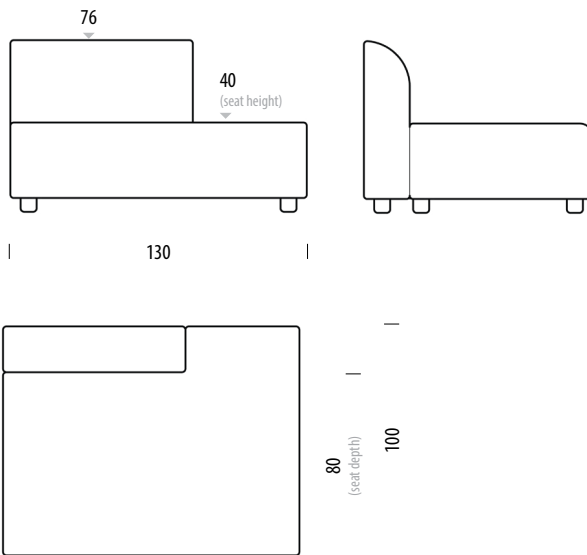

Item no. 56E

Removable fabric covers • Assembled module
Assembly between modules 5 min / 2 persons

Dimensions	Width	Depth	Height
Seat	80	80	40
Armrest	20	80	63

Selected options

Legs

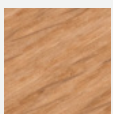

Lacquered
LUA468
Natural

Fabric upholstery



Main line flax
MLF02
Archway

Indicated materials and colours are selected by Gazzda as best-selling items. The lead time of selected options is 1-5 weeks. For an accurate lead time, please consult customer service.

For other material options, please see the Available materials section at the end of the product sheet.

Hugg Modular Sofa Left Open Ended - HLOE 130

Upholstery **Fabric**, Legs **Solid oak**

Basic info

Design Mustafa Čohadžić

Product size W: 130, D: 100, H: 76

Packaging W: 134, D: 104, H: 80

Volume 1,11 m³

Net weight 42,4 kg

Gross weight 49,9 kg

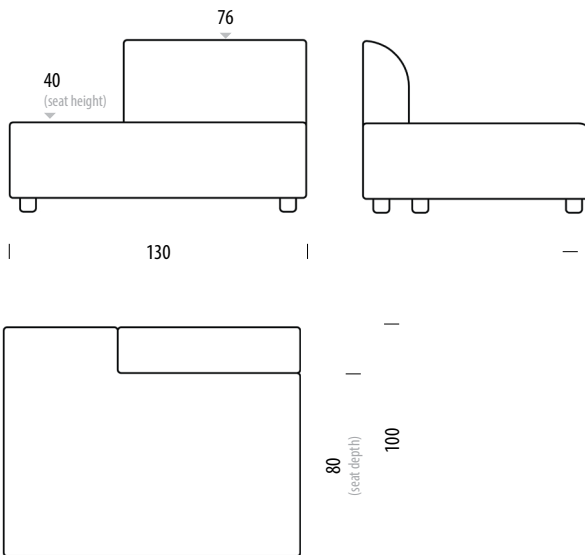

Item no. 561

Removable fabric covers • Assembled module
Assembly between modules 5 min / 2 persons

Dimensions	Width	Depth	Height
Seat	80	80	40
Armrest	20	80	63

Selected options

Legs

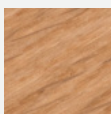

Lacquered
LUA468
Natural

Fabric upholstery

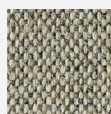

Main line flax
MLF02
Archway

Indicated materials and colours are selected by Gazzda as best-selling items. The lead time of selected options is 1-5 weeks. For an accurate lead time, please consult customer service.

For other material options, please see the Available materials section at the end of the product sheet.

Hugg Modular Sofa Middle 80 - HM 80

Upholstery **Fabric**, Legs **Solid oak**

Basic info

Design Mustafa Čohadžić

Product size W: 80, D: 100, H: 76

Packaging W: 84, D: 104, H: 80

Volume 0,7 m³

Net weight 30,9 kg

Gross weight 36,8 kg

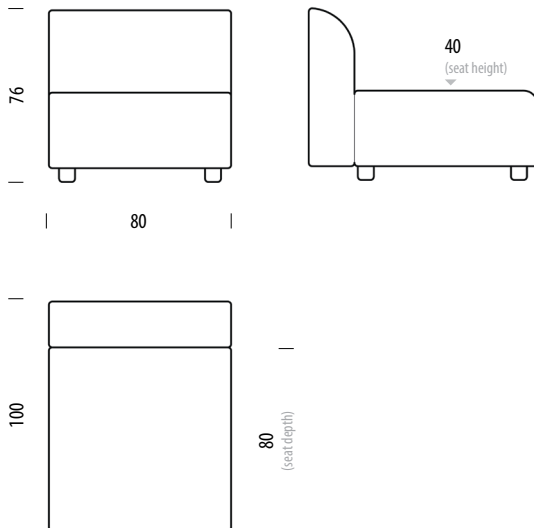

Item no. 564

Removable fabric covers • Assembled module
Assembly between modules 5 min / 2 persons

Dimensions	Width	Depth	Height
Seat	80	80	40

Selected options

Legs

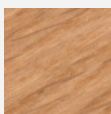

Lacquered
LUA468
Natural

Fabric upholstery

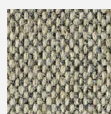

Main line flax
MLF02
Archway

Indicated materials and colours are selected by Gazzda as best-selling items. The lead time of selected options is 1-5 weeks. For an accurate lead time, please consult customer service.

For other material options, please see the Available materials section at the end of the product sheet.

Hugg Modular Sofa Middle 60 - HM 60

Upholstery **Fabric**, Legs **Solid oak**

Basic info

Design Mustafa Čohadžić

Product size W: 60, D: 100, H: 76

Packaging W: 64, D: 104, H: 80

Volume 0,53 m³

Net weight 25,4 kg

Gross weight 30,4 kg

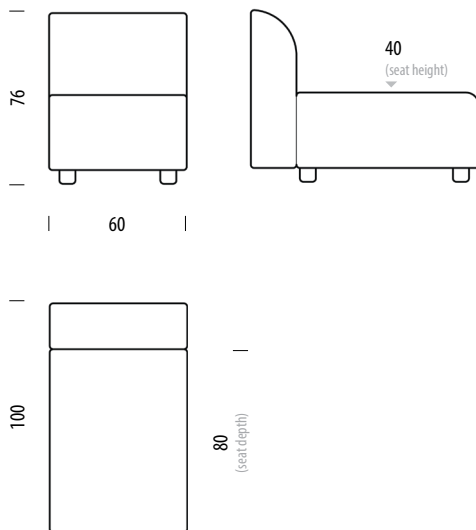

Item no. 3EC

Removable fabric covers • Assembled module
Assembly between modules 5 min / 2 persons

Dimensions	Width	Depth	Height
Seat	60	80	40

Selected options

Legs

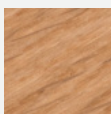

Lacquered
LUA468
Natural

Fabric upholstery



Main line flax
MLF02
Archway

Indicated materials and colours are selected by Gazzda as best-selling items. The lead time of selected options is 1-5 weeks. For an accurate lead time, please consult customer service.

For other material options, please see the Available materials section at the end of the product sheet.

Hugg Modular Sofa Ottoman - H0 60

Upholstery **Fabric**, Legs **Solid oak**

Version: 4-4-2023

Basic info

Design Mustafa Čohadžić

Product size W: 80, D: 60, H: 40

Packaging W: 83, D: 63, H: 47

Volume 0,25 m³

Net weight 14,1 kg

Gross weight 17,5 kg

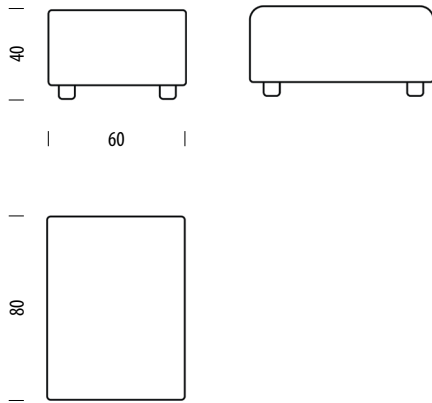

Item no. 566

Removable fabric covers • Assembled module
Assembly between modules 5 min / 2 persons

Dimensions	Width	Depth	Height
Seat	60	80	40

Selected options

Legs

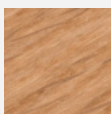

Lacquered
LUA468
Natural

Fabric upholstery

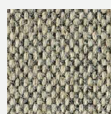

Main line flax
MLF02
Archway

Indicated materials and colours are selected by Gazzda as best-selling items. The lead time of selected options is 1-5 weeks. For an accurate lead time, please consult customer service.

For other material options, please see the Available materials section at the end of the product sheet.

Hugg Pillow 50 x 40

Material **Fabric**

Version: 4-4-2023

Basic info

Design	Mustafa Čohadžić
Product size	W: 45, D: 35, H: 16
Packaging	W: 50, D: 40, H: 16,5
Volume	0,04 m ³
Net weight	0,7 kg
Gross weight	0,75 kg

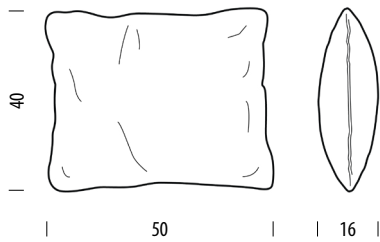

Item no. 442

Removable pillowcase

Selected options

Fabric upholstery



Main line flax
MLF02
Archway

Indicated materials and colours are selected by Gazzda as best-selling items. The lead time of selected options is 1-5 weeks. For an accurate lead time, please consult customer service.

For other material options, please see the Available materials section at the end of the product sheet.

Hugg Pillow 70 x 40

Material **Fabric**

Basic info

Design	Mustafa Čohadžić
Product size	W: 65, D: 35, H: 16
Packaging	W: 70, D: 40, H: 16,5
Volume	0,05 m ³
Net weight	1,1 kg
Gross weight	1,15 kg

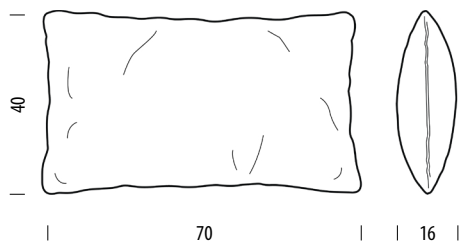

Item no. 441

Removable pillowcase

Selected options

Fabric upholstery



Main line flax
MLF02
Archway

Indicated materials and colours are selected by Gazzda as best-selling items. The lead time of selected options is 1-5 weeks. For an accurate lead time, please consult customer service.

For other material options, please see the Available materials section at the end of the product sheet.

Hugg Pillow 60 x 60

Material **Fabric**

Version: 4-4-2023

Basic info

Design	Mustafa Čohadžić
Product size	W: 55, D: 55, H: 16
Packaging	W: 60, D: 60, H: 16,5
Volume	0,06 m ³
Net weight	1,65 kg
Gross weight	1,7 kg

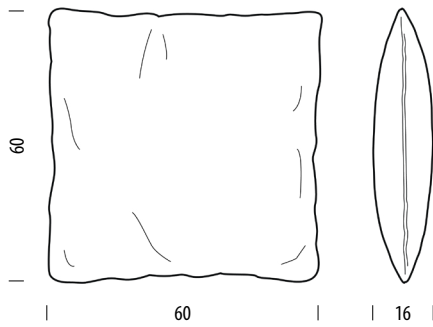

Item no. 443

Removable pillowcase

Selected options

Fabric upholstery



Main line flax
MLF02
Archway

Indicated materials and colours are selected by Gazzda as best-selling items. The lead time of selected options is 1-5 weeks. For an accurate lead time, please consult customer service.

For other material options, please see the Available materials section at the end of the product sheet.

Loop Sofa Table

Plate Oak veneer / Linoleum, Base Powder-coated steel

Basic info

Design Mustafa Čohadžić

Product size W: 22, D: 35, H: 57

Packaging W: 66, D: 26, H: 14

Volume 0,024 m³

Net weight 5,9 kg

Gross weight 8,3 kg

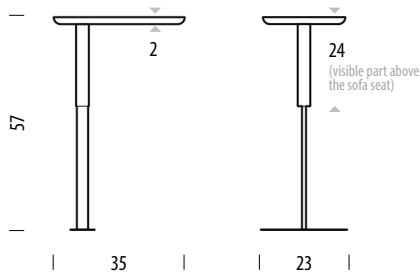

Item no. 58D

Revolving plate • Assembly 15 min / 2 person

Plate	Thickness (cm)
	2

Selected options

Oak veneer plate



Lacquered
LUA468
Natural



Lacquered
RAL 9005
Black

Linoleum plate



Linoleum
4176
Mushroom



Linoleum
4023
Nero

Metal finish



RAL 1013
Mushroom



RAL 9005
Black

Indicated materials and colours are selected by Gazzda as best-selling items. Please consult the current price list or our customer service for the lead time of selected options.

Hugg Modular Sofa

Modules overview

Version: 4-4-2023

End, lounge, open-ended, freestanding, corner and table
Modules

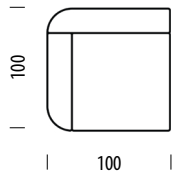

Left Armrest - HLA 80
Item no. 44F

W: 100, D: 100, H: 76

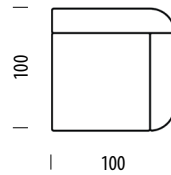

Right Armrest - HRA 80
Item no. 569

W: 100, D: 100, H: 76

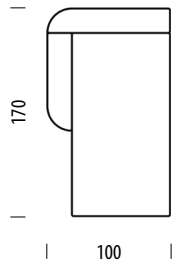

Left Lounge Armrest - HLLA 170
Item no. 55F

W: 100, D: 170, H: 76

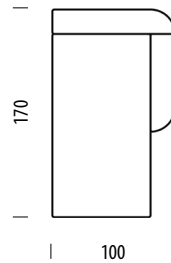

Right Lounge Armrest - HRLA 170
Item no. 56B

W: 100, D: 170, H: 76

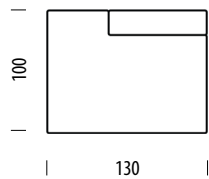

Left Open Ended - HLOE 130
Item no. 561

W: 130, D: 100, H: 76

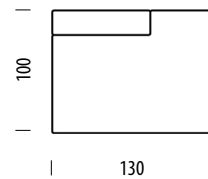

Right Open Ended - HROE 130
Item no. 56E

W: 130, D: 100, H: 76

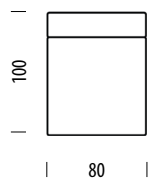

Middle 80 - HM 80
Item no. 564

W: 80, D: 100, H: 76

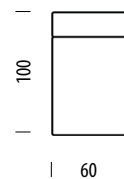

Middle 60 - HM 60
Item no. 3EC

W: 60, D: 100, H: 76

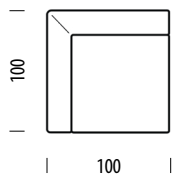

Corner - HC 80
Item no. 3ED

W: 100, D: 100, H: 76

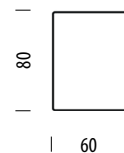

Ottoman - HO 60
Item no. 566

W: 60, D: 80, H: 76

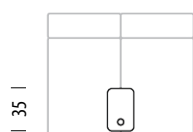

Loop Sofa Table
Item no. 58D

W: 22, D: 35, H: 57

| 22 |

Hugg Modular Sofa

Configurations

Version: 4-4-2023

2 Seater Configurations

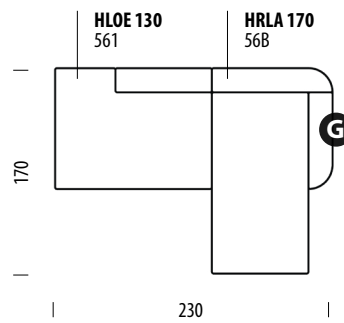
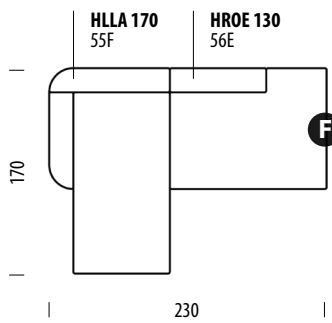
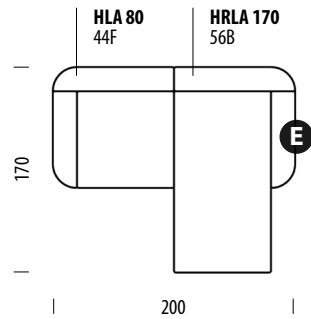
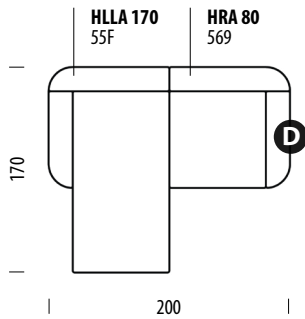
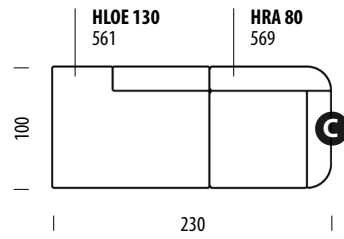
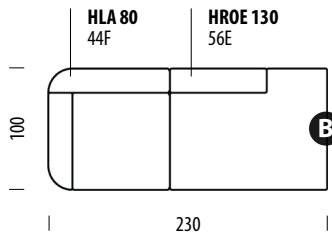
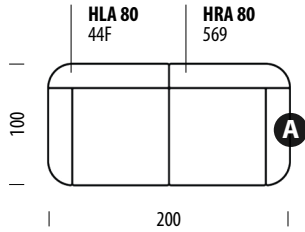

Hugg Modular Sofa

Configurations

Version: 4-4-2023

3 Seater Configurations

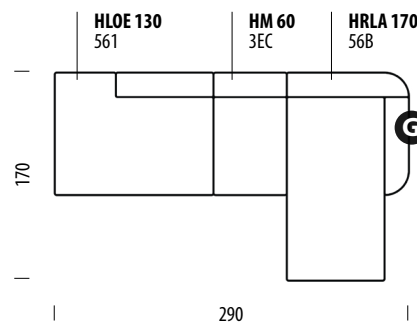
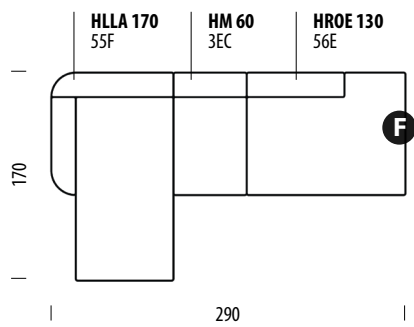
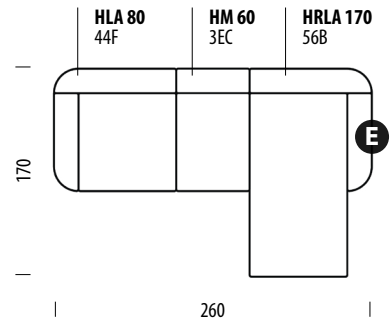
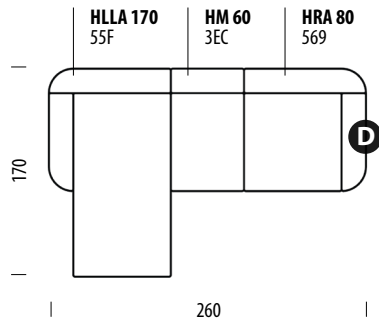
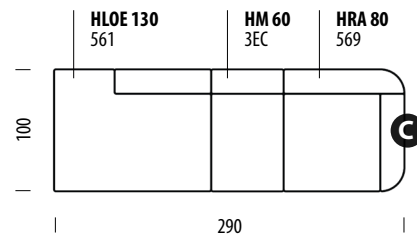
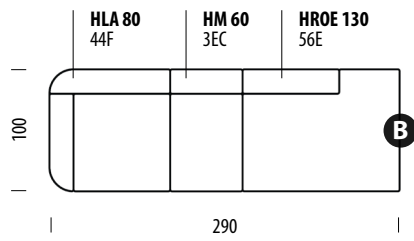
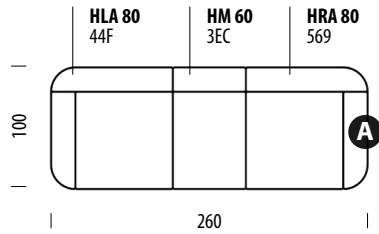

Hugg Modular Sofa

Configurations

Version: 4-4-2023

3 Plus Seater Configurations

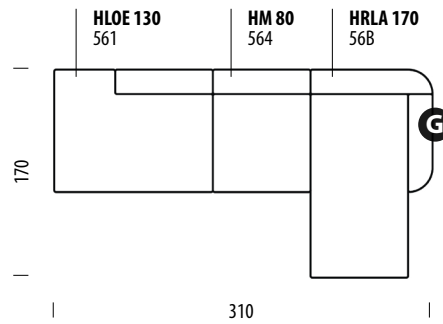
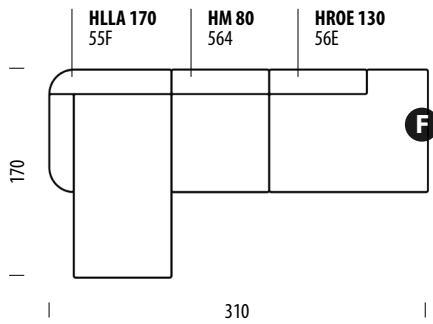
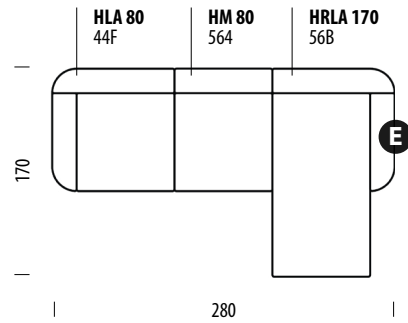
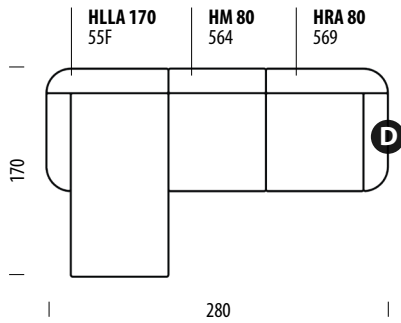
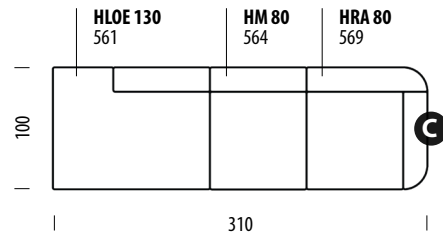
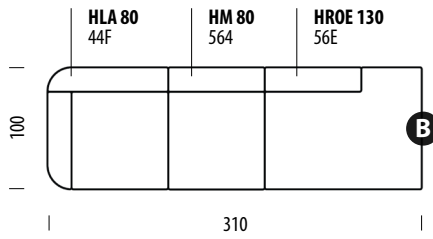
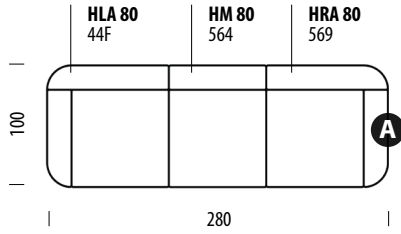

Hugg Modular Sofa

Configurations

Version: 4-4-2023

4 Seater Configurations

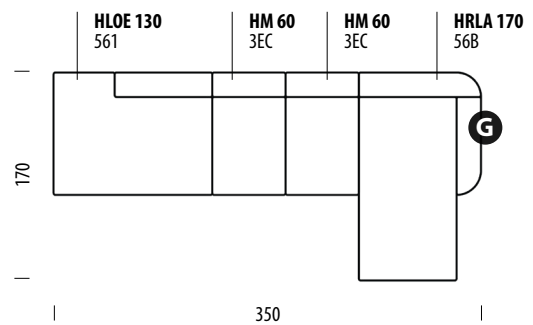
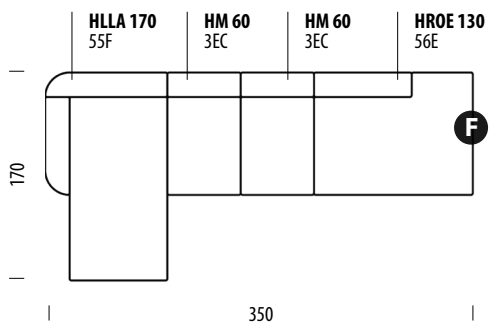
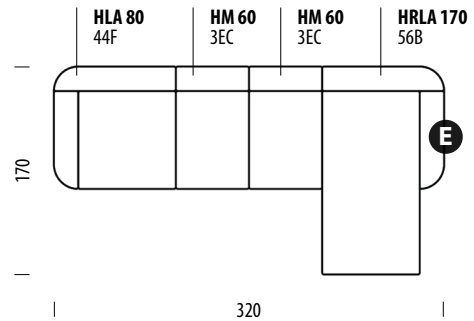
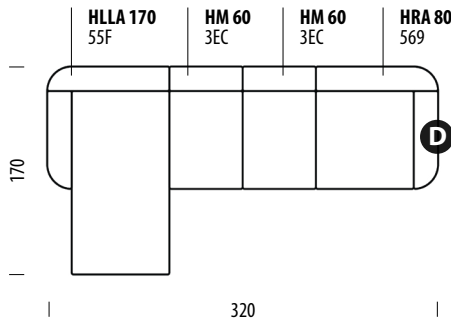
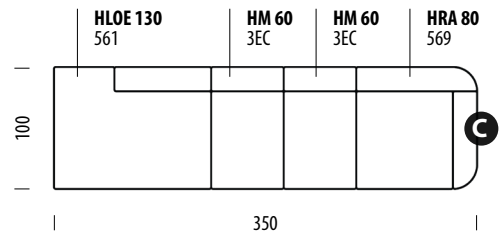
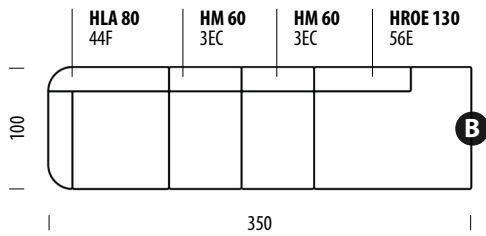
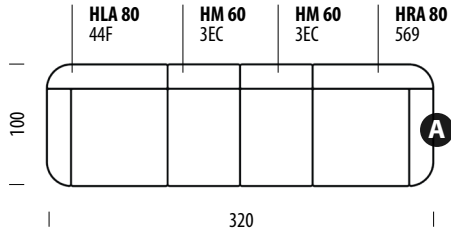

Hugg Modular Sofa

Configurations

Version: 4-4-2023

4 Plus Seater Configurations

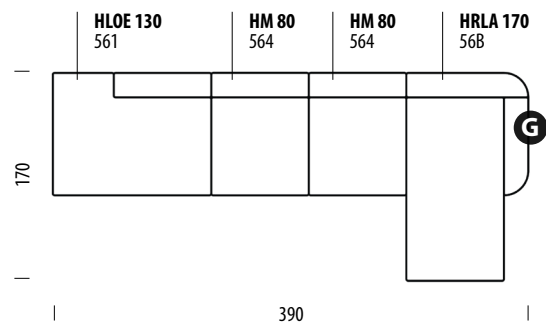
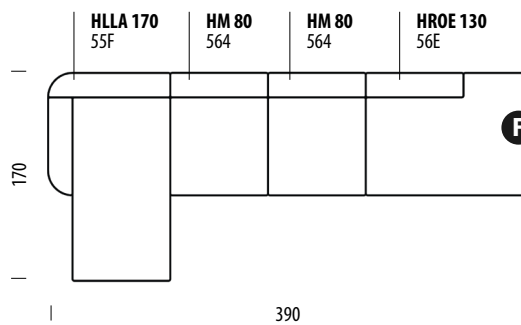
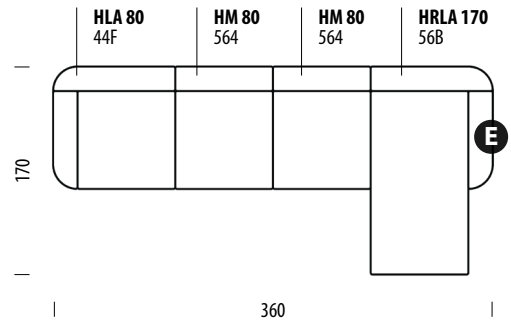
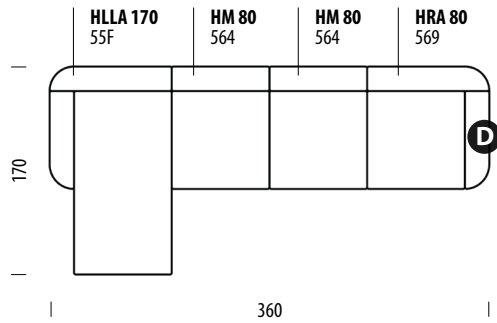
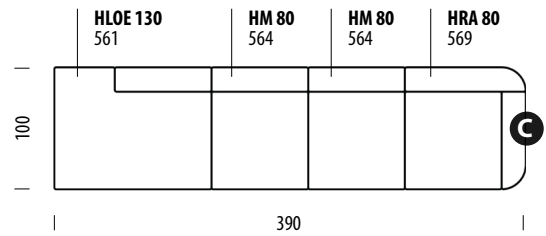
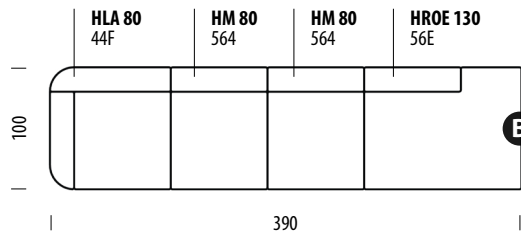
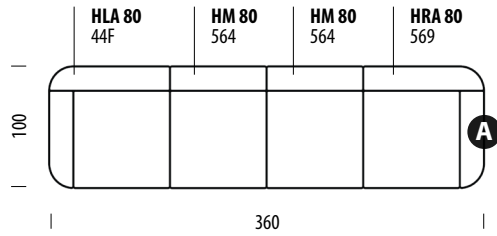

Hugg Modular Sofa

Configurations

Version: 4-4-2023

Corner Configurations

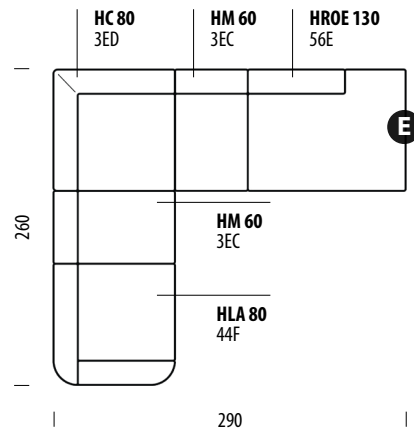
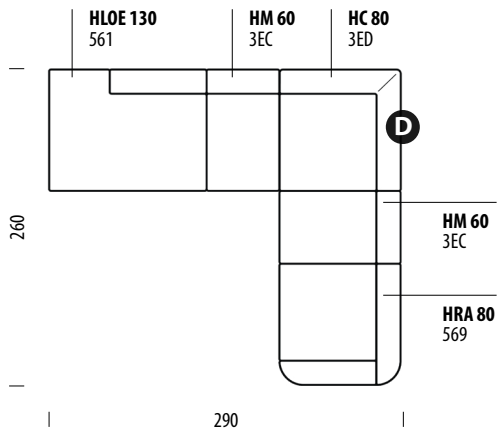
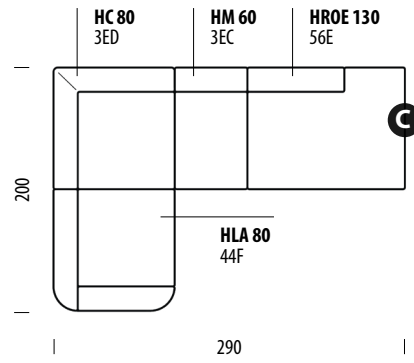
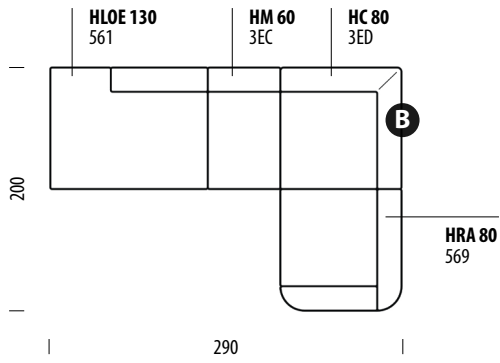
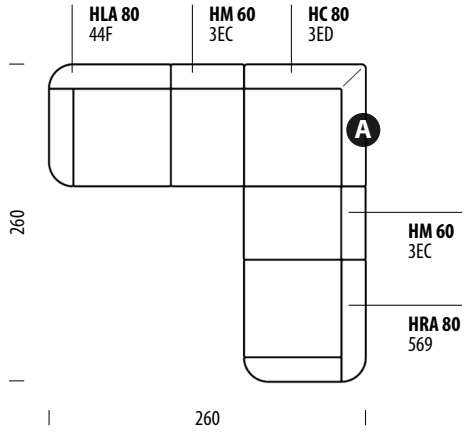

Hugg Modular Sofa

Configurations

Version: 4-4-2023

Corner Plus Configurations

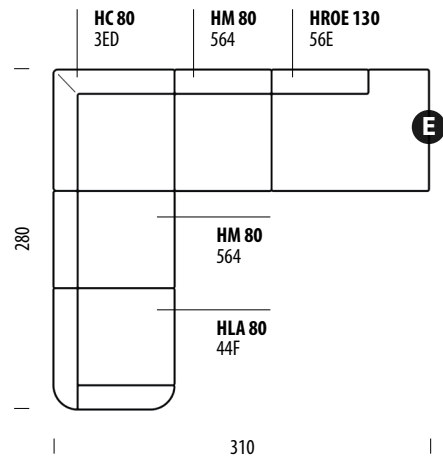
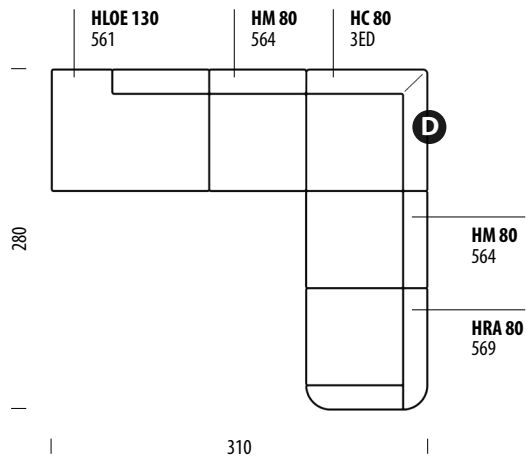
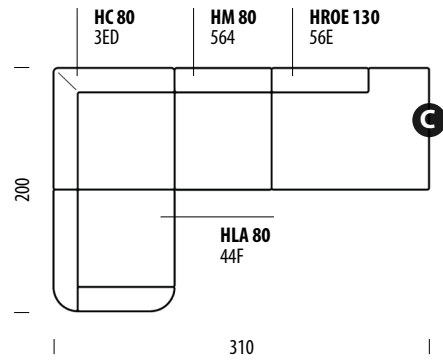
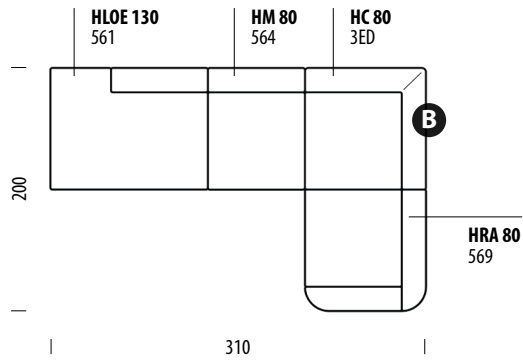
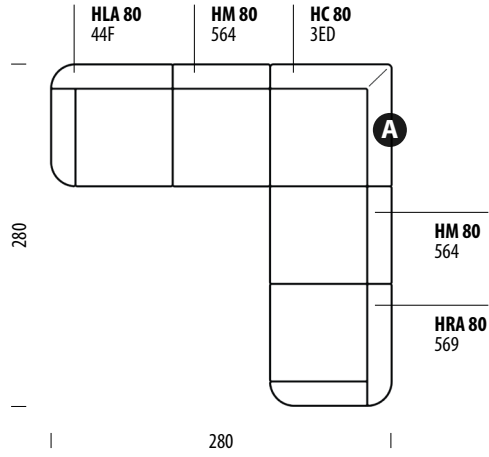

Hugg Modular Sofa

Available materials

Version: 4-4-2023

Wooden parts | Oak

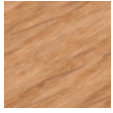

Lacquered
LUA468
Natural



Lacquered
RAL 9005
Black

Upholstery | Fabric

Main line flax - by Camira



MLF16
Temple



MLF20
Upminster



MLF02
Archway

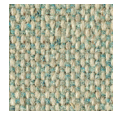

MLF10
Newbury

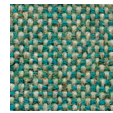

MLF24
Bayswater

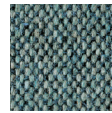

MLF22
Westminster



MLF32
Greenford

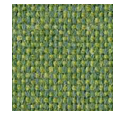

MLF18
Tufnell



MLF17
Tooting

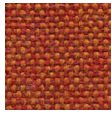

MLF13
Leyton

Vidar - by Kvadrat



0182



0133



0222

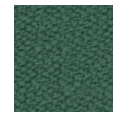

0943



0733



0872



0582



0472

Remix - by Kvadrat



0753

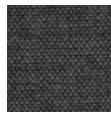

0163

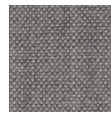

0123



0823

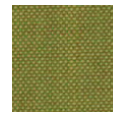

0912

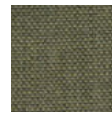

0933



0612

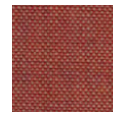

0632



0762

Hugg Modular Sofa

Available materials

Upholstery | Fabric

Oceanic - by Camira

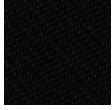

OOC01
Flotsam

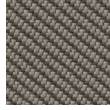

OOC08
Bay

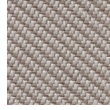

OOC14
Riptide



OOC13
Paddle



OOC11
Neptune

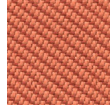

OOC05
Coral

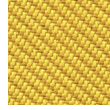

OOC07
Barrier

Yoredale - by Camira



UDA08
Gayle



UDA25
Leyburn

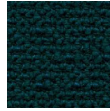

UDA17
Ribble



UDA10
Cray



UDA04
Hardraw



UDA02
Kidstone



UDA03
Askrigg

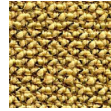

UDA05
Simonstone

Loop Sofa Table

Available materials

Version: 4-4-2023

Plate | Oak veneer

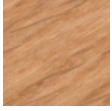

Lacquered
LUA468
Natural



Lacquered
RAL 9005
Black

Metal base | Powder-coated steel

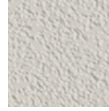

Mushroom
RAL 1013

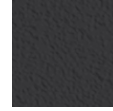

Black
RAL 9005

Plate | Desktop linoleum - by Forbo



4176
Mushroom



4023
Nero

Note

Desktop linoleum colors are chosen to go in line with powder coated metal base: Linoleum Nero with Black RAL 9005 and Mushroom linoleum Mushroom RAL 1013.